

12. DETAIL 12 - DOOR OPENING  
SCALE 1:5

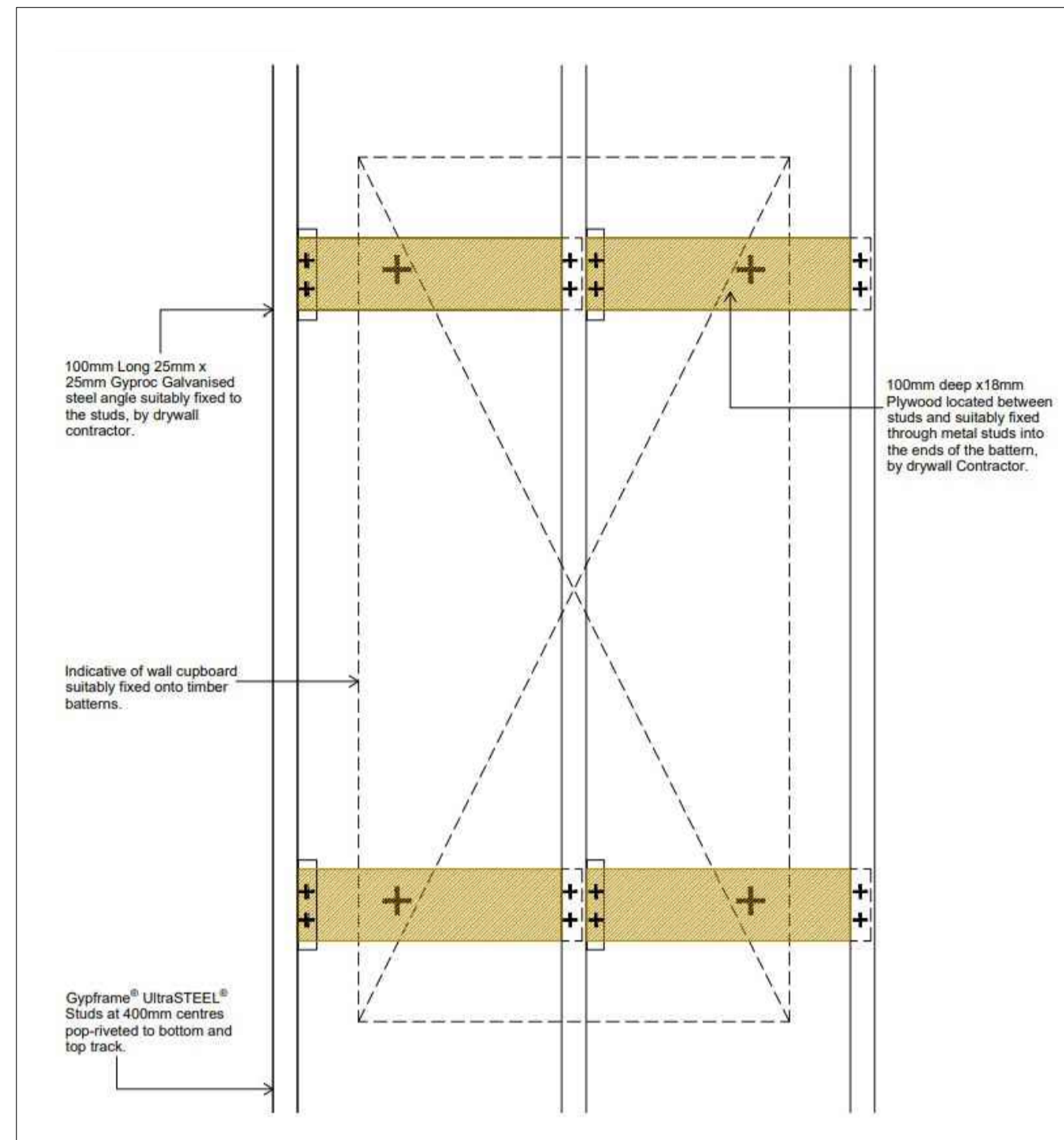

13. DETAIL 13 - CUPBOARD FIXING  
SCALE 1:5

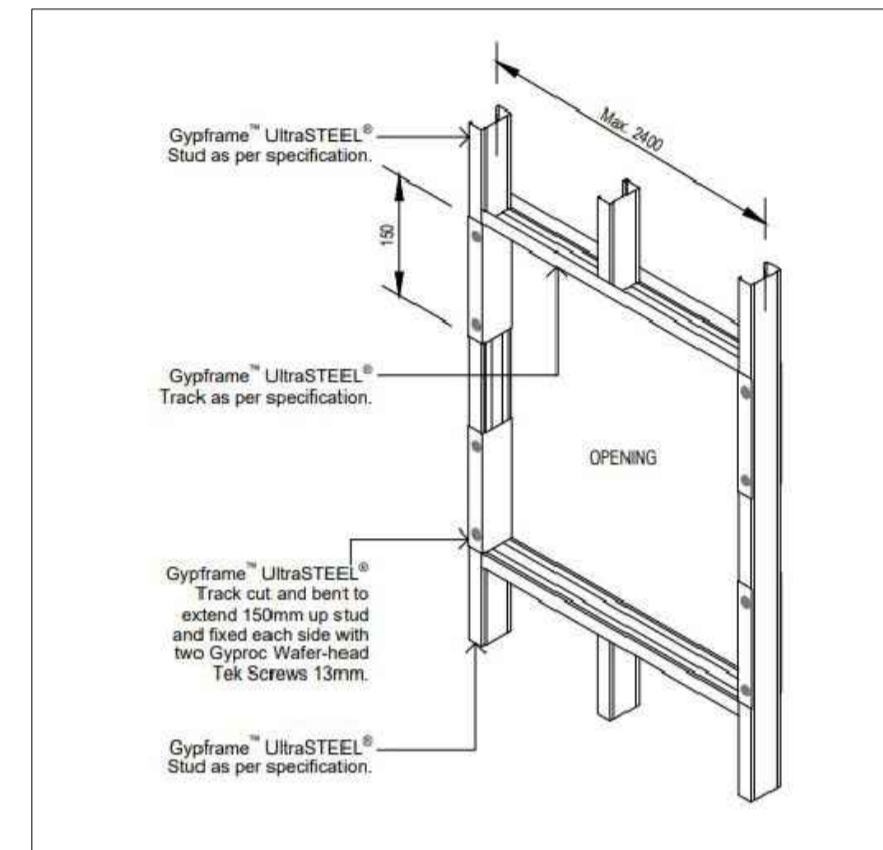

14. DETAIL 14 - FRAMEWORK PENETRATIONS  
SCALE 1:5

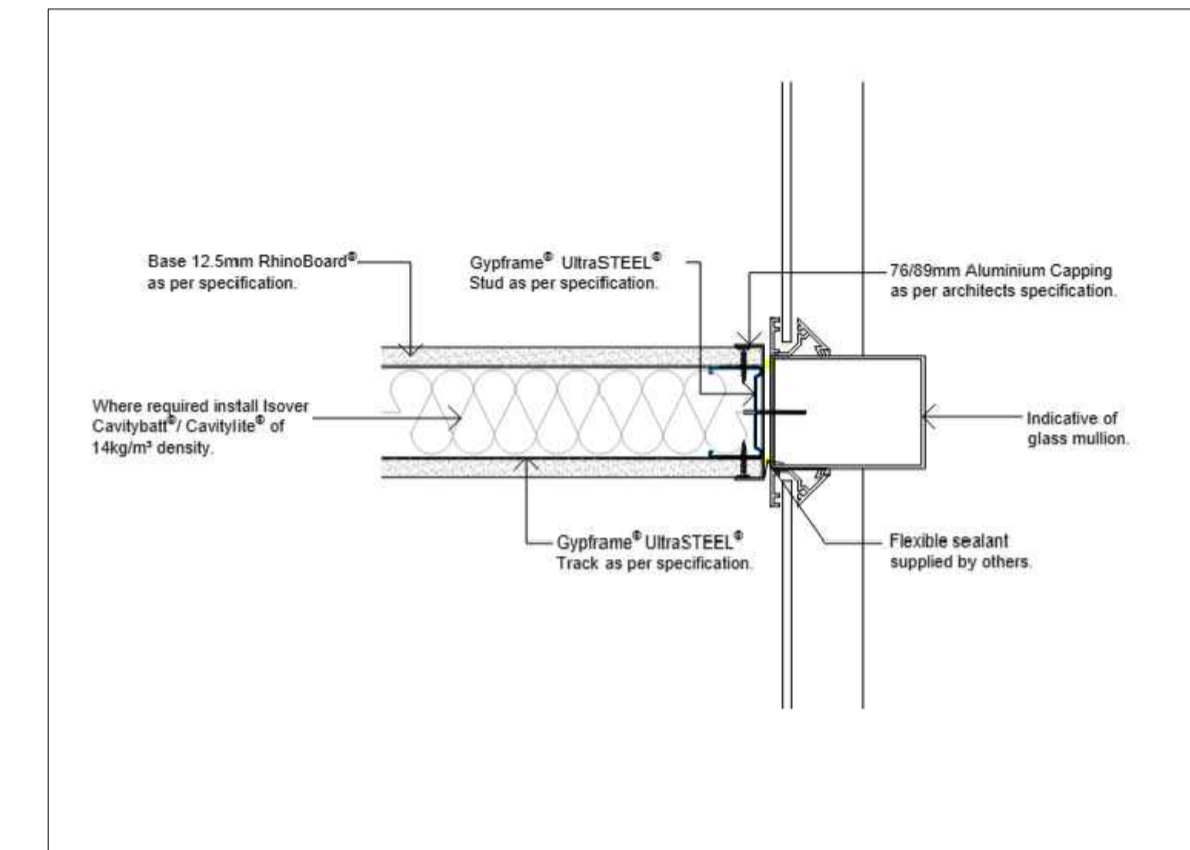

15. DETAIL 15 - ABUTMENT DETAIL - PARTITION TO MULLION  
SCALE 1:5

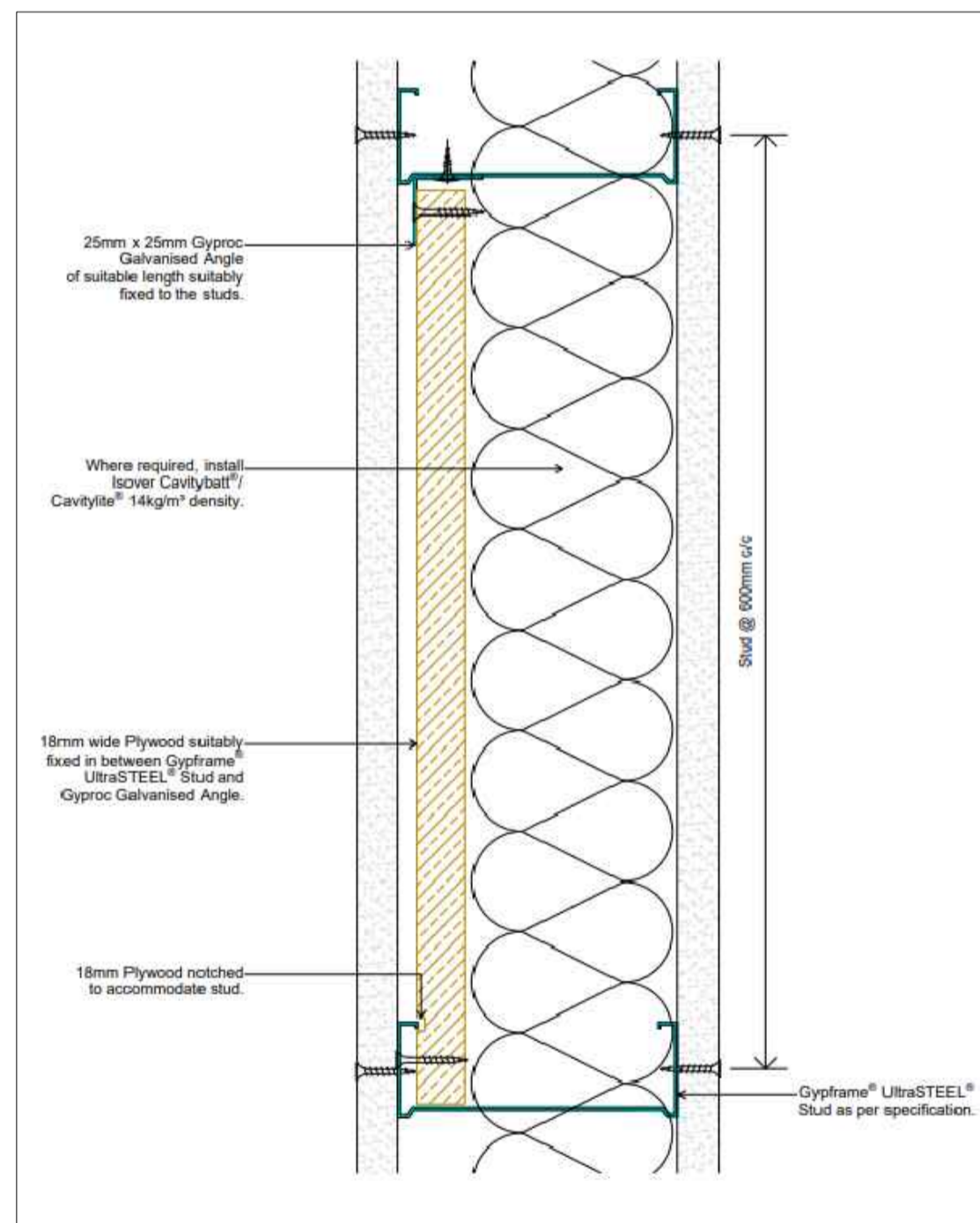

07. DETAIL 07 - PARTITION NOGGIN DETAIL  
SCALE 1:5

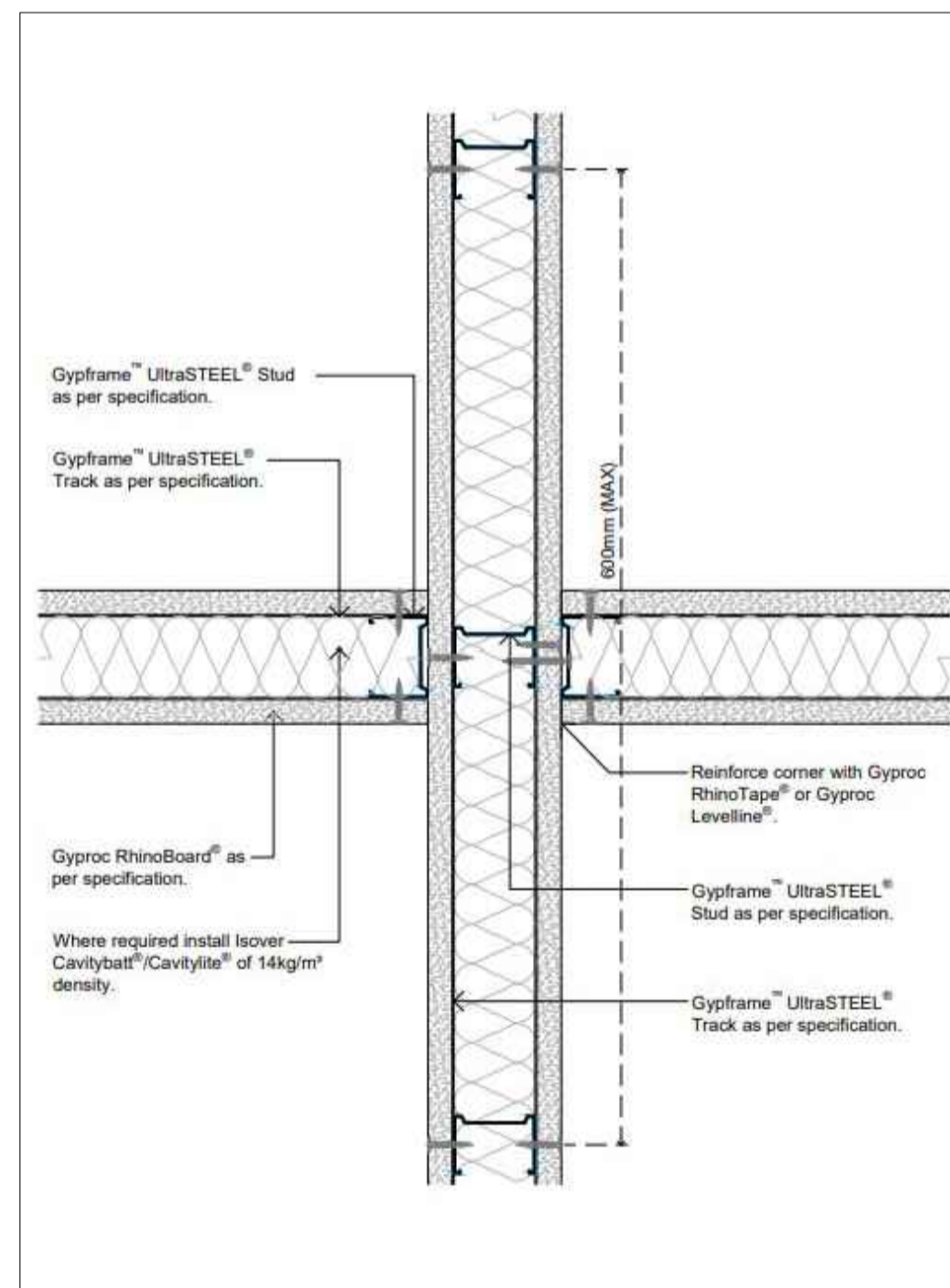

08. DETAIL 08 - PARTITION CROSS SECTION DETAIL  
SCALE 1:5

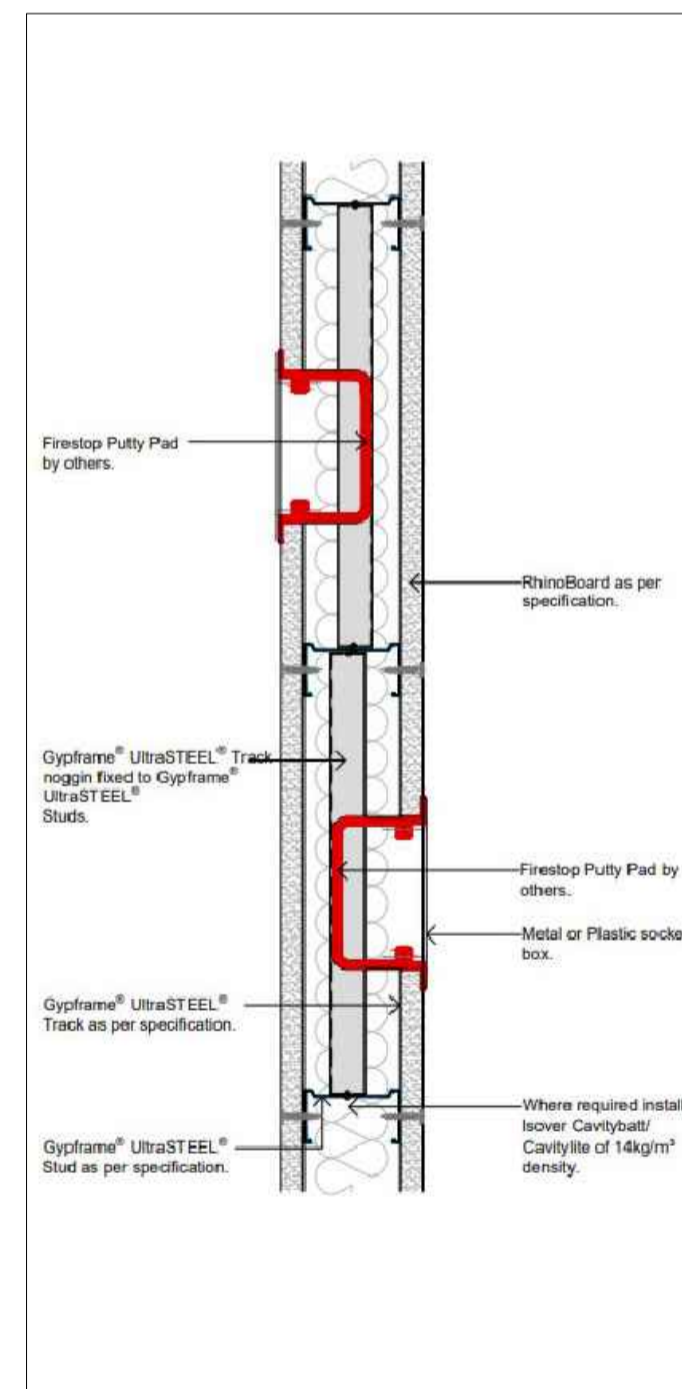

09. DETAIL 09 - SOCKET WITH ULTRASTEEL FRAMEWORK & PUTTY PAD 60MIN FIRE RATING  
SCALE 1:5

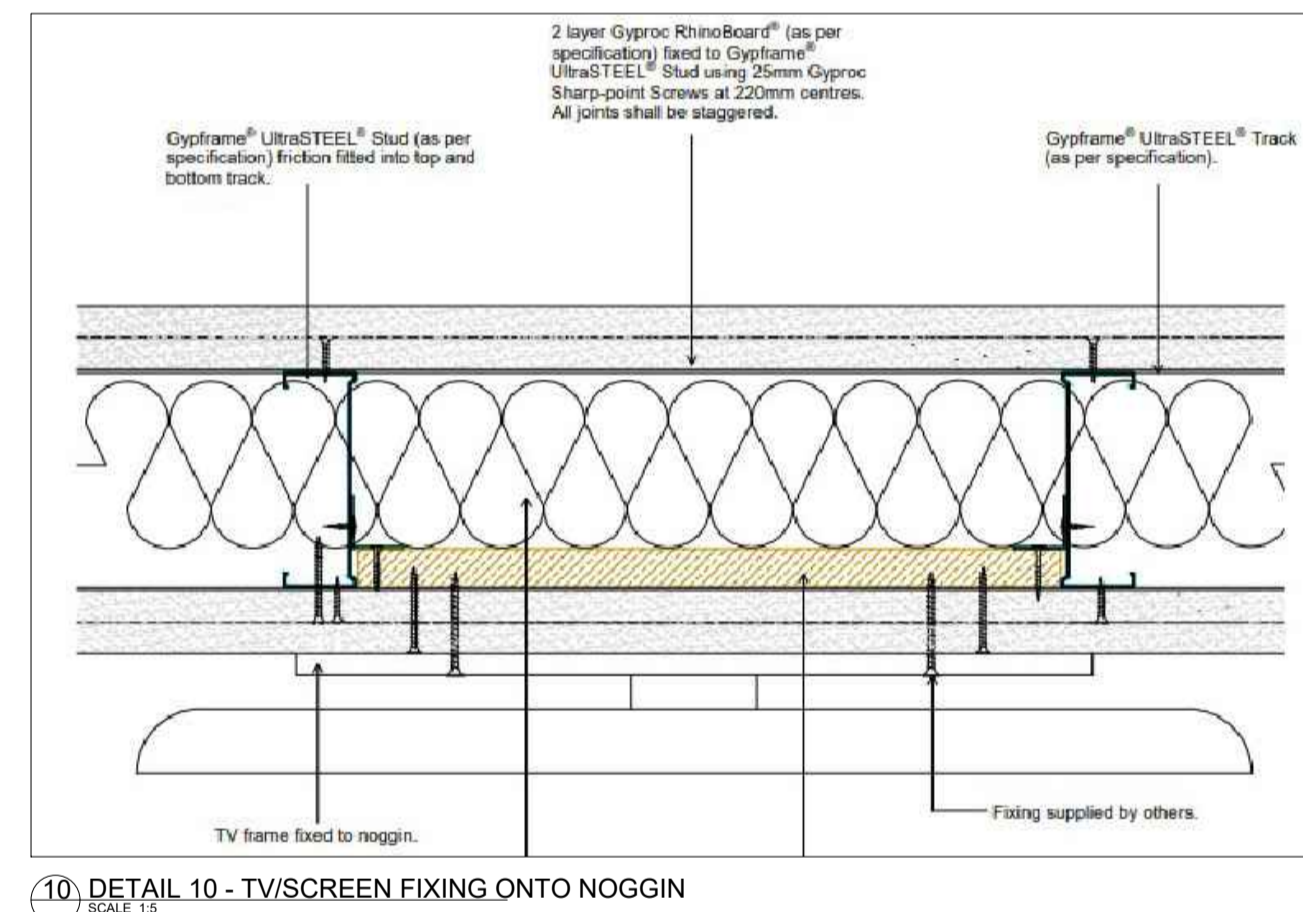

10. DETAIL 10 - TV/SCREEN FIXING ONTO NOGGIN  
SCALE 1:5

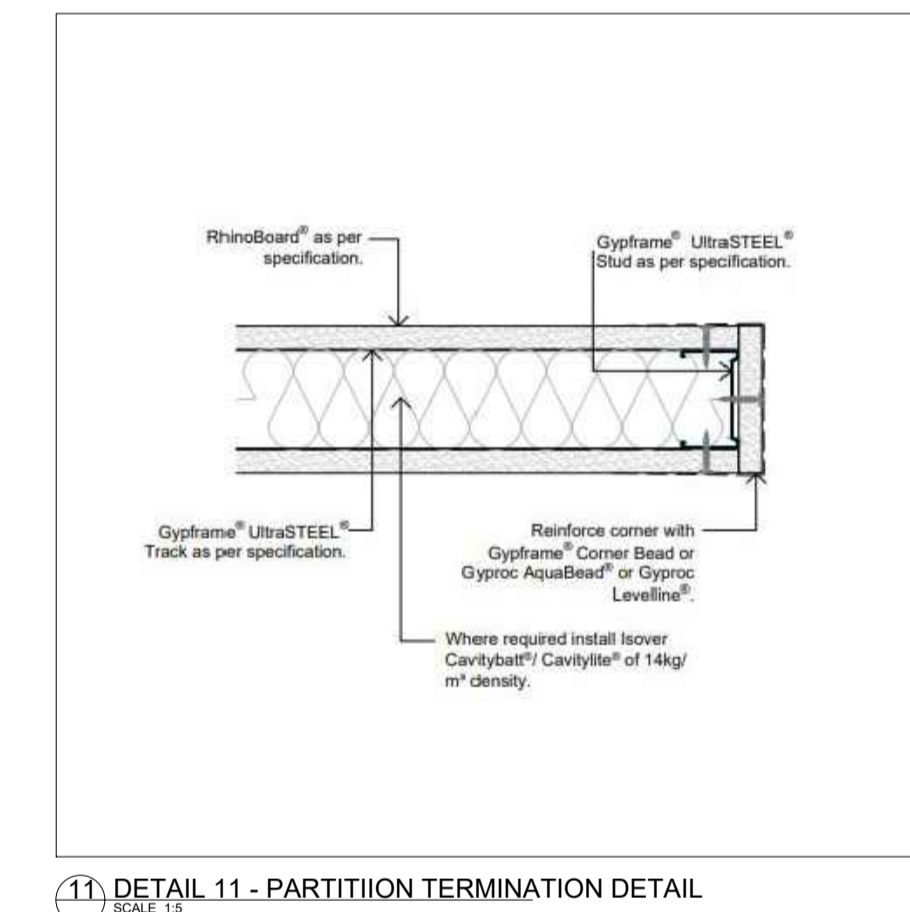

11. DETAIL 11 - PARTITION TERMINATION DETAIL  
SCALE 1:5

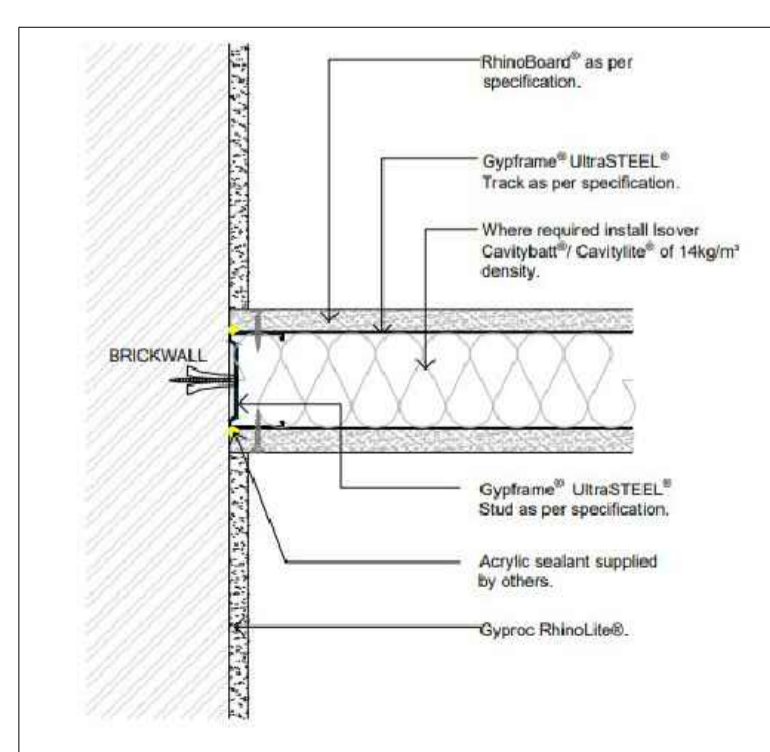

01. DETAIL 01 - ABUTMENT DETAIL - WALL & PARTITION  
SCALE 1:5

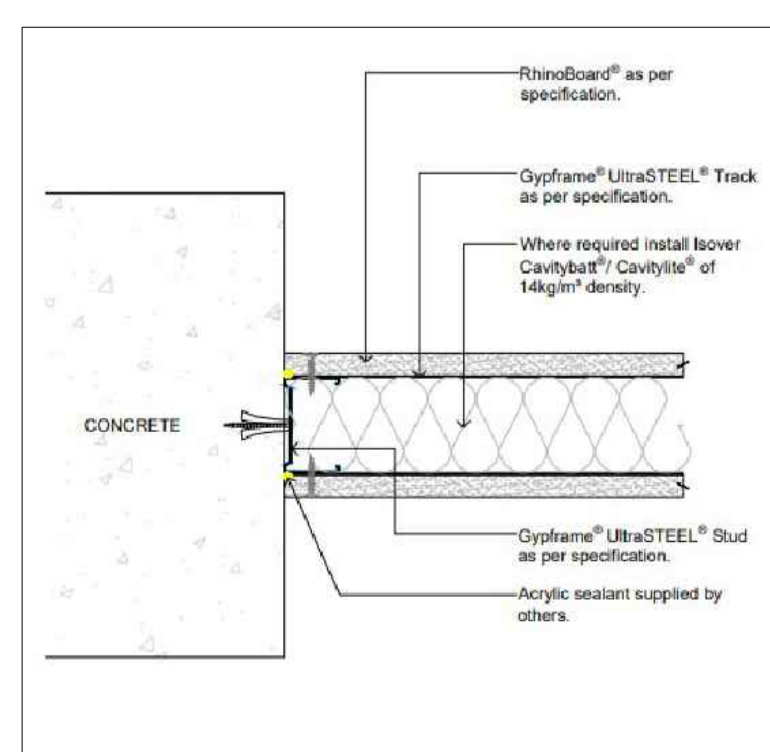

02. DETAIL 02 - ABUTMENT DETAIL - COLUMN & PARTITION  
SCALE 1:5

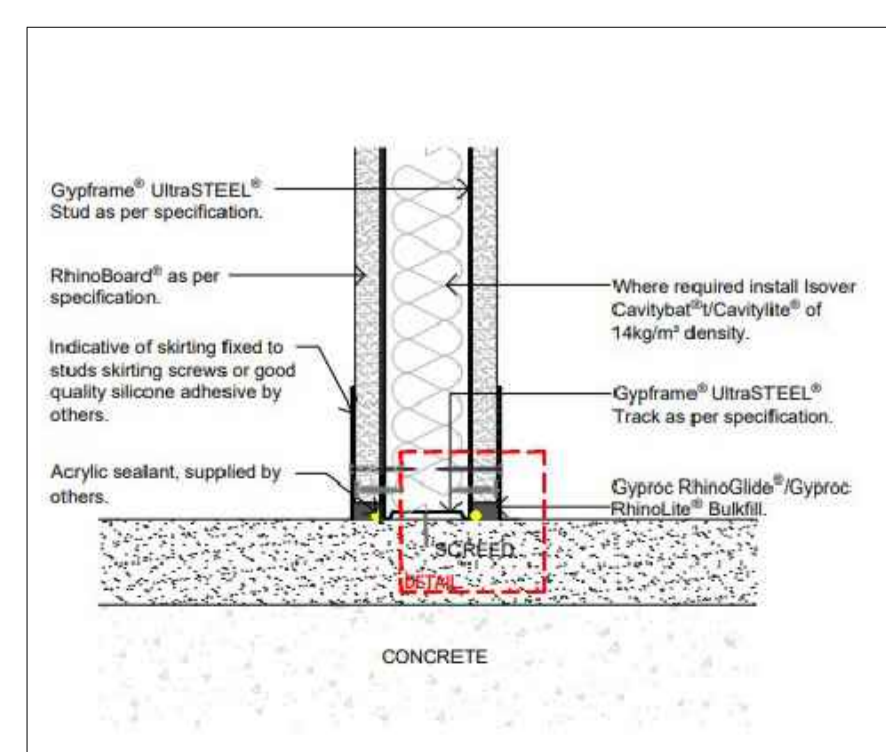

03. DETAIL 03 - BASE DETAIL - ALUMINIUM SKIRTING  
SCALE 1:5

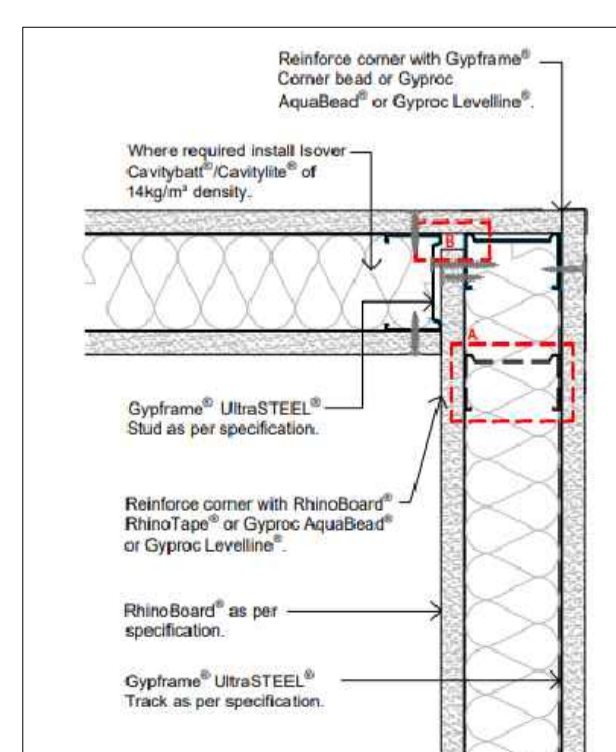

04. DETAIL 04 - PARTITION CORNER DETAIL  
SCALE 1:5

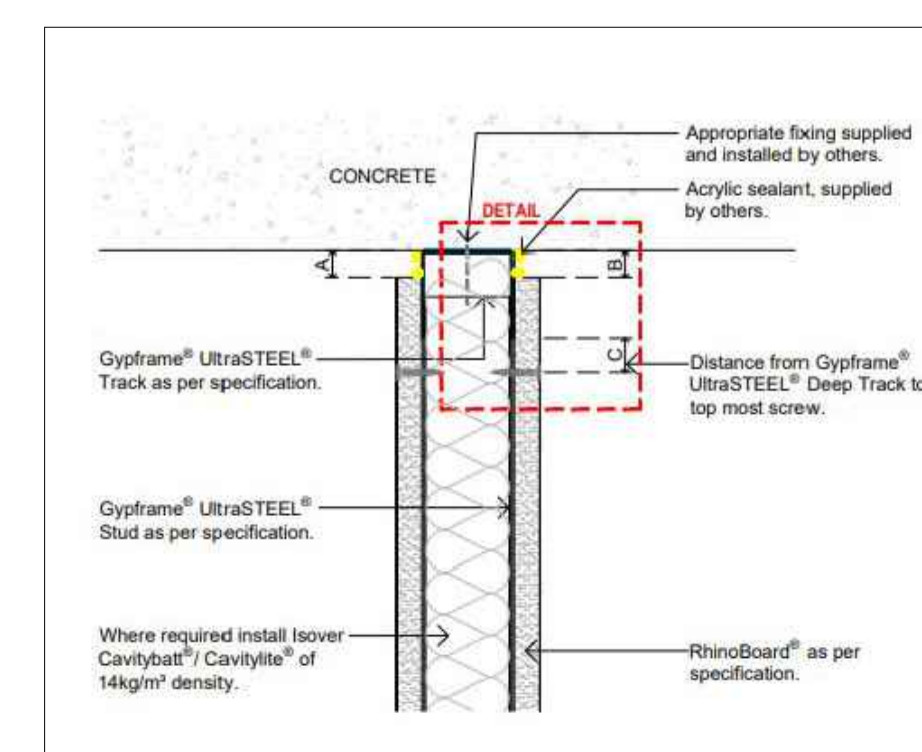

05. DETAIL 05 - PARTITION SOFFIT DETAIL  
SCALE 1:5

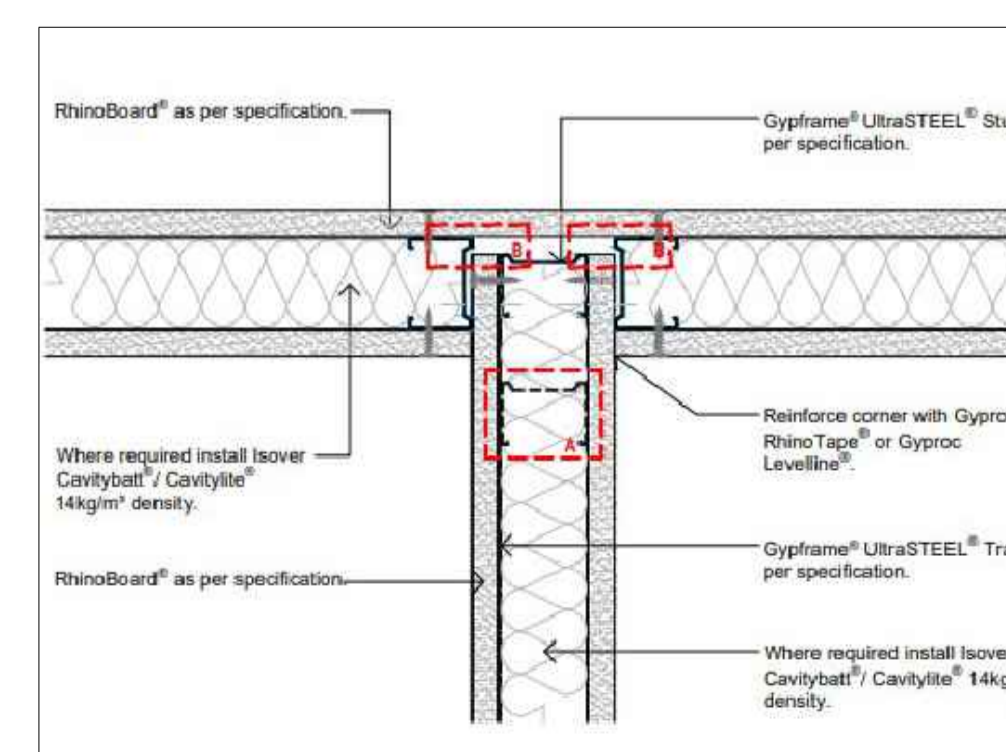

06. DETAIL 06 - PARTITION T-JUNCTION DETAIL  
SCALE 1:5

revision	description	date
A	COSTING ISSUE	2023-11-27

Dimensions to be checked on site prior to fabrication.  
No dimensions to be scaled from this drawing.  
Report all discrepancies to Collaboration.  
COPYRIGHT ©

COLLABORATION

First Floor, Swindon House, 179 Bultengracht Street, Cape Town  
Tel: 0027 21 448 8686

GENERAL ARRANGEMENT  
PARTITION TYPES

WESGRO  
SEVENTH AND EIGHTH FLOOR  
MEDIA 24 BUILDING  
ERF 244  
40 HEERENGRACHT STREET, CAPE TOWN

scale	date	drawn	chkd
AS SHOWN	2023-11-27	ZN	DS

drawing number	revision
1982/0A/GA/21	A